

● Standard Dimensions

■ Model MF10-15XB

■ Model MF10-15XBD (without flexible coupling)

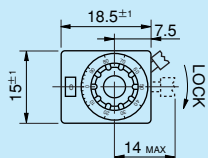

■ Model MF10-15YB

■ Model MF10-15YBD (without flexible coupling)

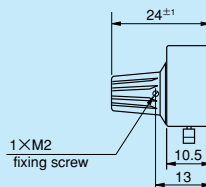
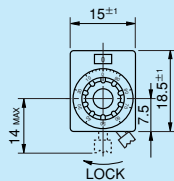

■ Model MF20-22B

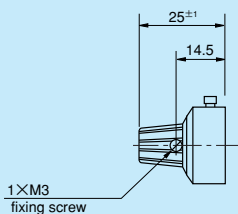
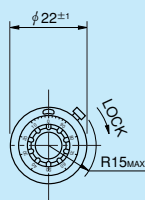

■ Model MF20-46B

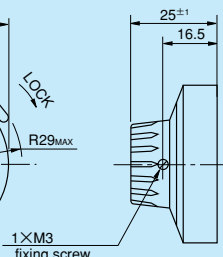
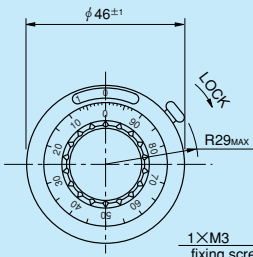

Panel Arrangements

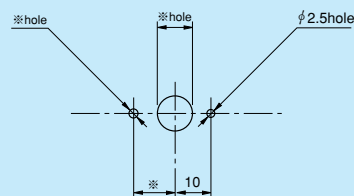
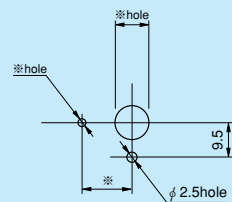
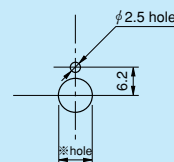

Note: The dimensions of mark ※ are determined by the pot. to be mounted.

Model MF10-15XB

Model MF10-15YB

Model MF20-22B

Model MF20-46B

Construction of MF Dial

Flexible coupling incorporated

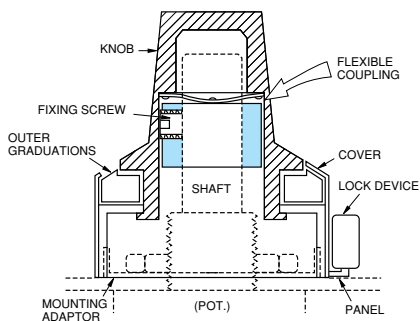

SAKAE MF dial is provided with a flexible coupling situated between the shaft of the potentiometer to be mounted and inner dial knob and therefore, the connection is entirely free and only the force of rotating direction is transmittable. With such unique device, traditional trouble such as irregular rotation and ununiform torque due to inaccurate mounting of the potentiometer on dial can be easily solved. Even the unskilled can mount this MF dial and you can save the labor cost using this MF dial.

CAUTION: When rotating MF dial mounted with multi-turn potentiometer with over 20N (2kgf.) force, the flexible coupling may be damaged or broken. So, please take care of this fact during its operation.

● General Specifications

Model No	Number of Turns-Counting.	Matching Shaft Dia. (mm)		Combinable Helicalohm Pot. (Matching shaft length of 25mm)			Patented Flexible Coupling	Lock Device	Operating Temperature Range	Mass (Approx. g)
		Standard	Special							
MF10-15B	10	3	3.175, 4	10HP	25HP	12HP	YES	YES	-30°C~+60°C	15
MF10-15BD				12HHP	12HPC		NO			
MF20-22B	20	6	3, 3.175, 4, 6.35	10HP 12HP 20HHP 22HHP	12HHP 12HPC 20HP 22HP	25HP 46HD	YES	YES	-30°C~+60°C	17
MF20-46B	20	6	6.35	20HP 22HP	25HP 46HD	20HHP 22HHP	YES	YES	-30°C~+60°C	50

Mounting Adaptors for use with MF & DB Series

■ For Model MF10-15B
■ For Model MF10-15BD

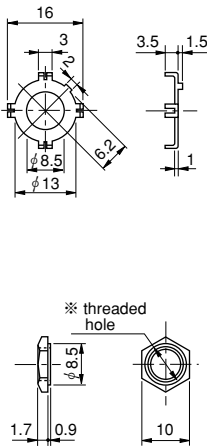

■ For Model MF20-22B
■ For Model DB10-26B

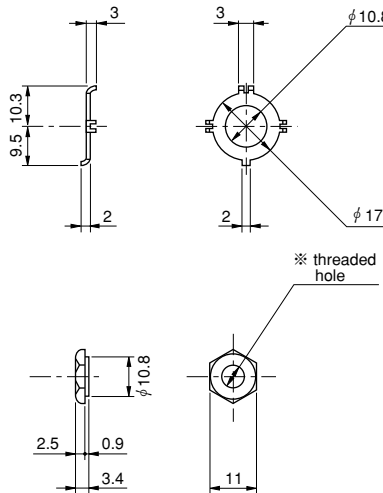

■ For Model MF20-46B

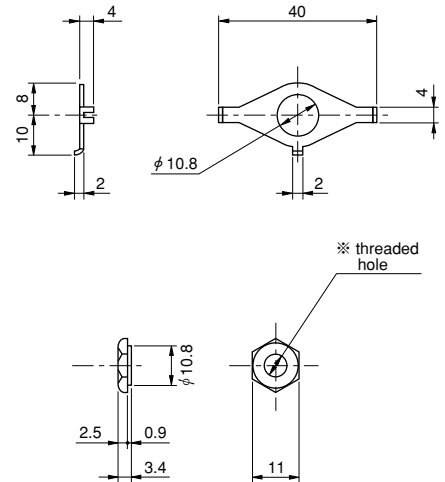

Note: The dimensions of mark ※ are determined by the potentiometer to be mounted.

How to mount MF Series

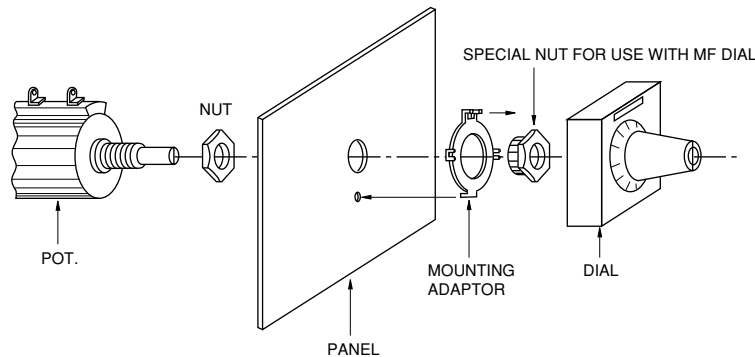

The mounting adaptor as well as specially shaped nut only for use with Model MF Series Dials and Helicalohm pot. are fixed on the panel according to the illustration given above.

The shaft of the Helicalohm pot. is turned anticlockwise to its limit and is put into the mounting hole of the dial which was already set at "0" At the same time, 4

projections of the mounting adaptor are inserted in 4 receiving holes prepared on the base plate of the dial and then all parts should be pressed to the panel firmly to eliminate any space. The shaft of the potentiometer is fixed by the hexagonal nut positioned in the knob of the dial by screwing it with an attached hexagonal wrench. With this, the mounting is completed.